











釜利谷ジャンクション コントロールポイント平面図

凡 例

- | | | | |
|-----------------------------------------------------------------------------------|--------|-----------------------------------------------------------------------------------|---------|
|  | 日野ずい道 |  | 横々 本線 |
|  | 朝比奈送水管 |  | 横々 ランプ |
|  | 水路トンネル |  | 横々 橋梁 |
|  | 道路トンネル |  | 横々 トンネル |
|  | 鉄塔 |  | 横々 跨道橋 |

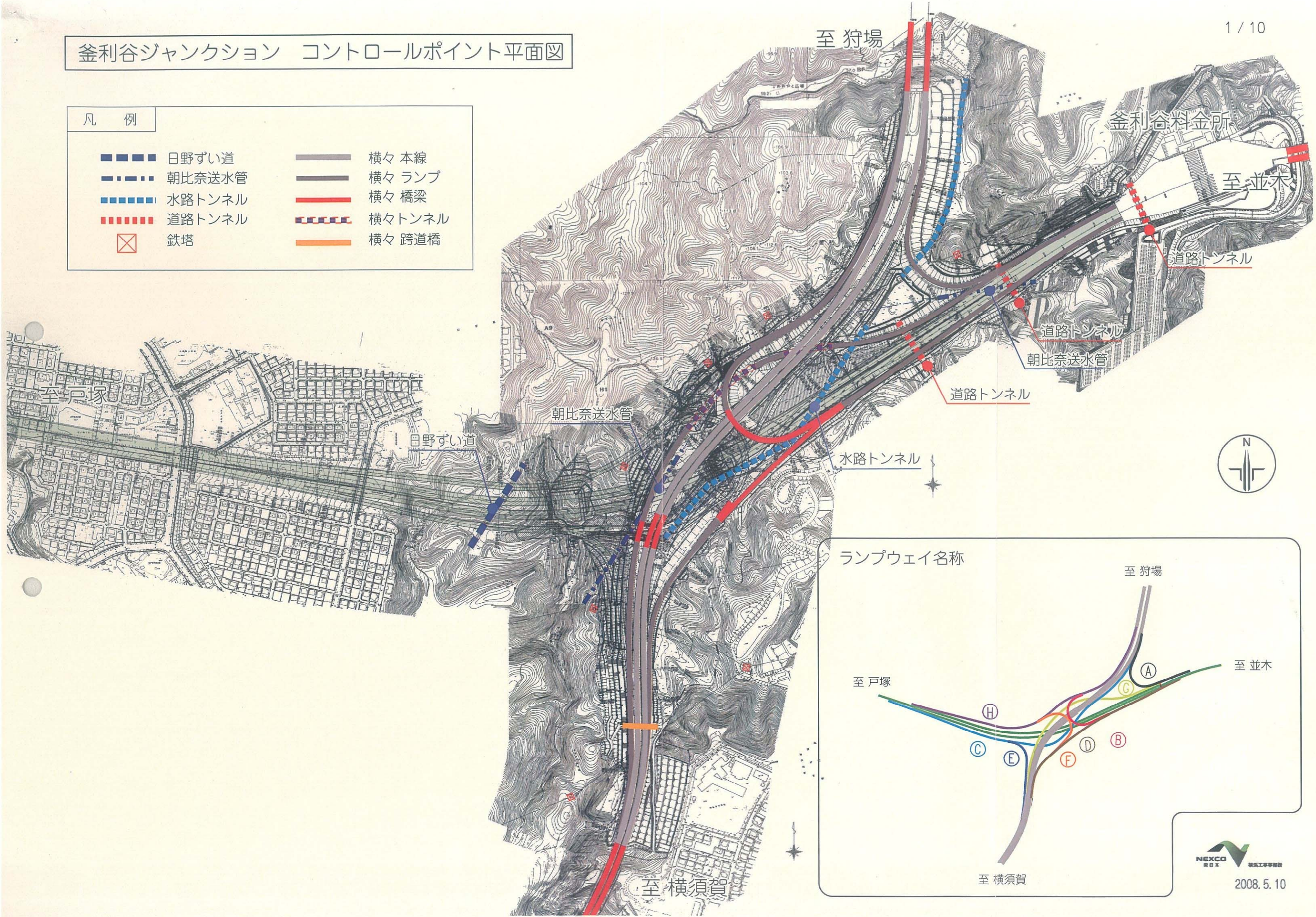

ランプウェイ名称

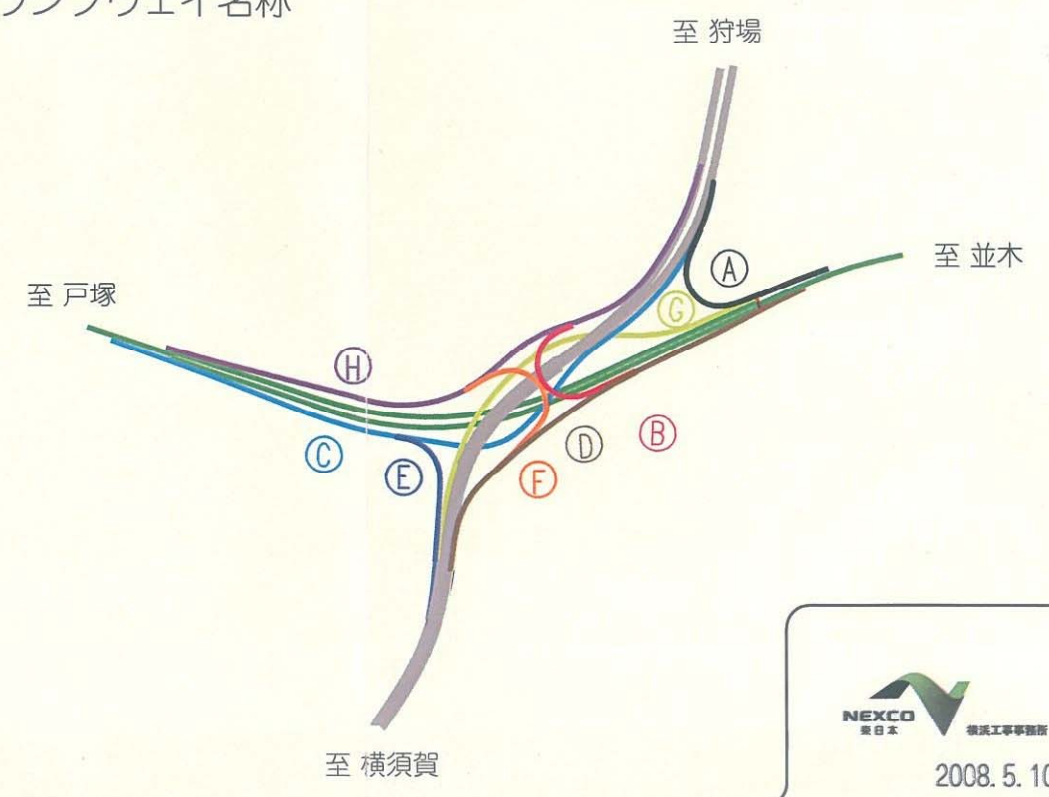

釜利谷ジャンクション～神戸橋付近 コントロールポイント縦断面図

— 現計画
— 神戸橋の下越し案

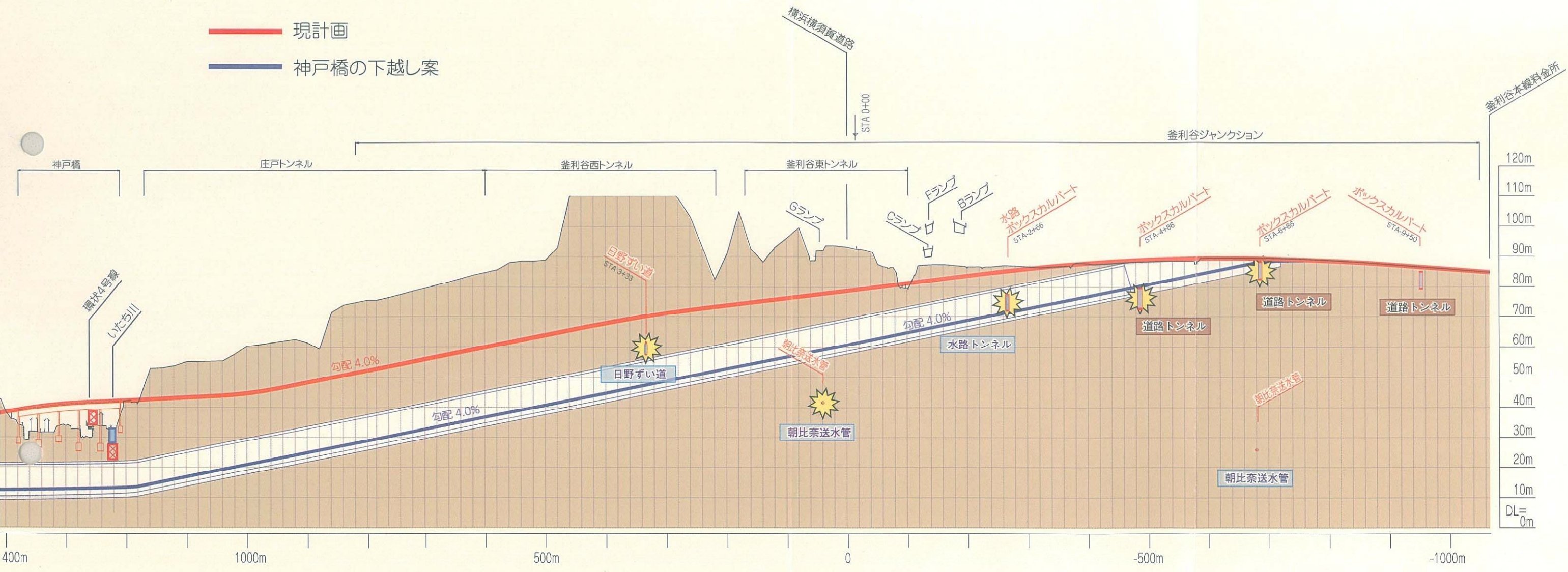

※横軸は縦軸のスケールに対して1/4に縮めています。

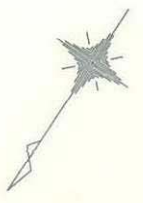

釜利谷ジャンクション

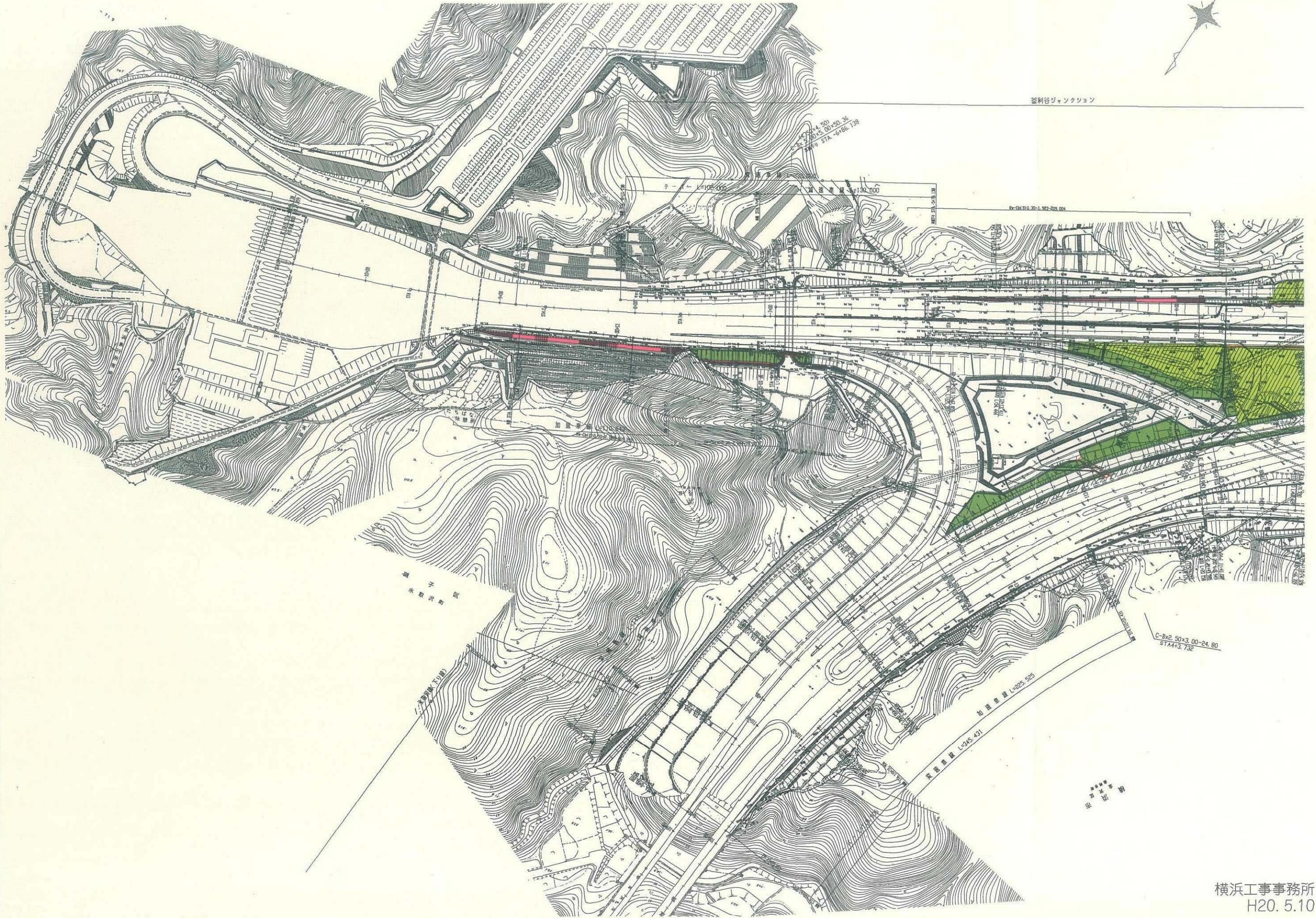

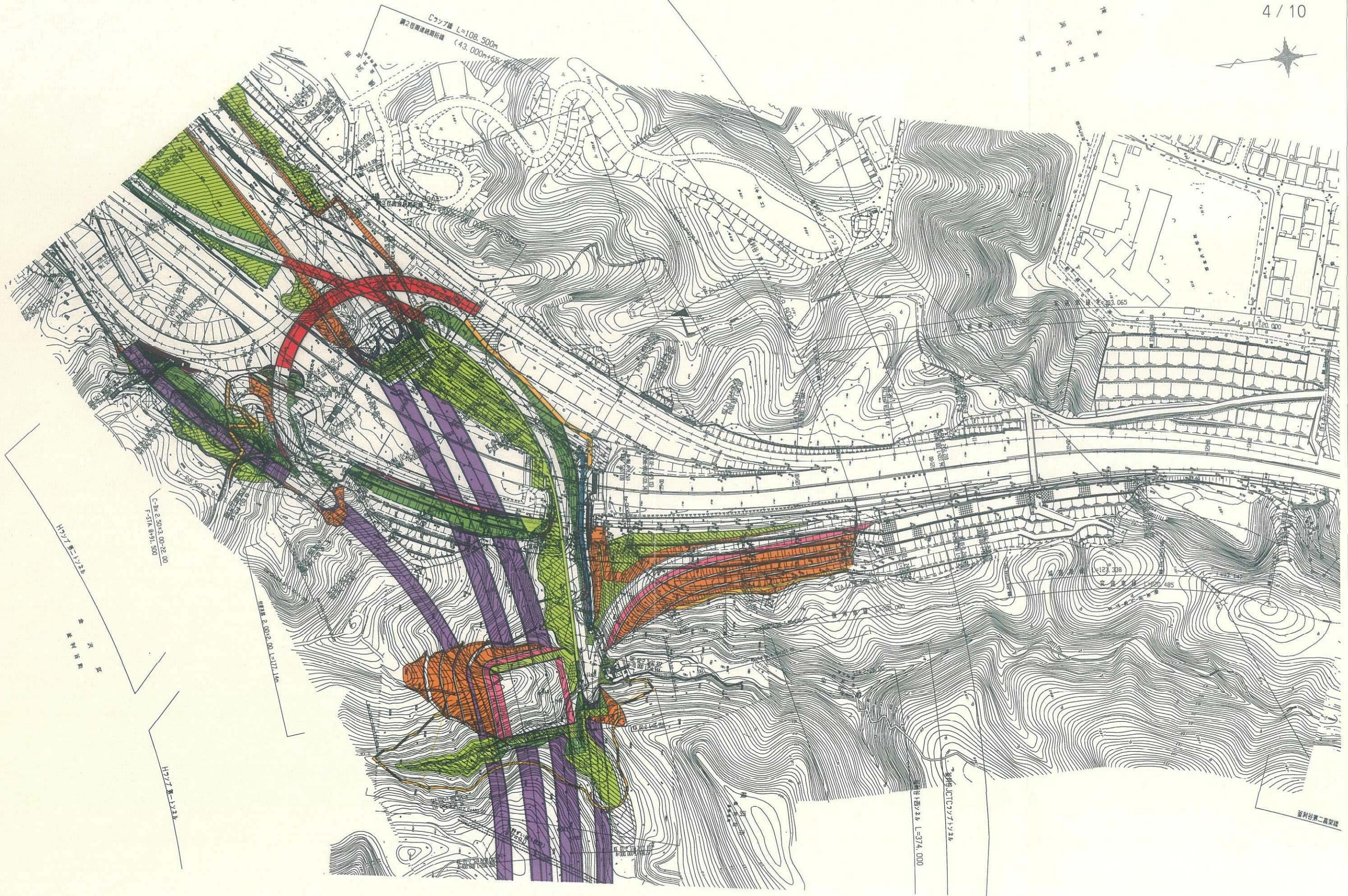
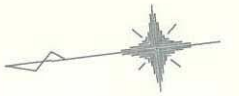

クラフ橋 L=108.500m
第2区間建設期折橋 (43.000m+65%)

C-302 50.3.00-22.00
F-51A 8.91.500

H27J 第2区間

区
天
橋
区

H27J 第1区間

H27J 第2区間

第1区間建設期折橋 L=374.000m
第2区間建設期折橋 L=374.000m

第2区間建設期折橋



釜利谷JCTランプトンネル

釜利谷西トンネル L=374.000

庄戸トンネル L=570.000

STA.6+000.000

STA.11+700.000

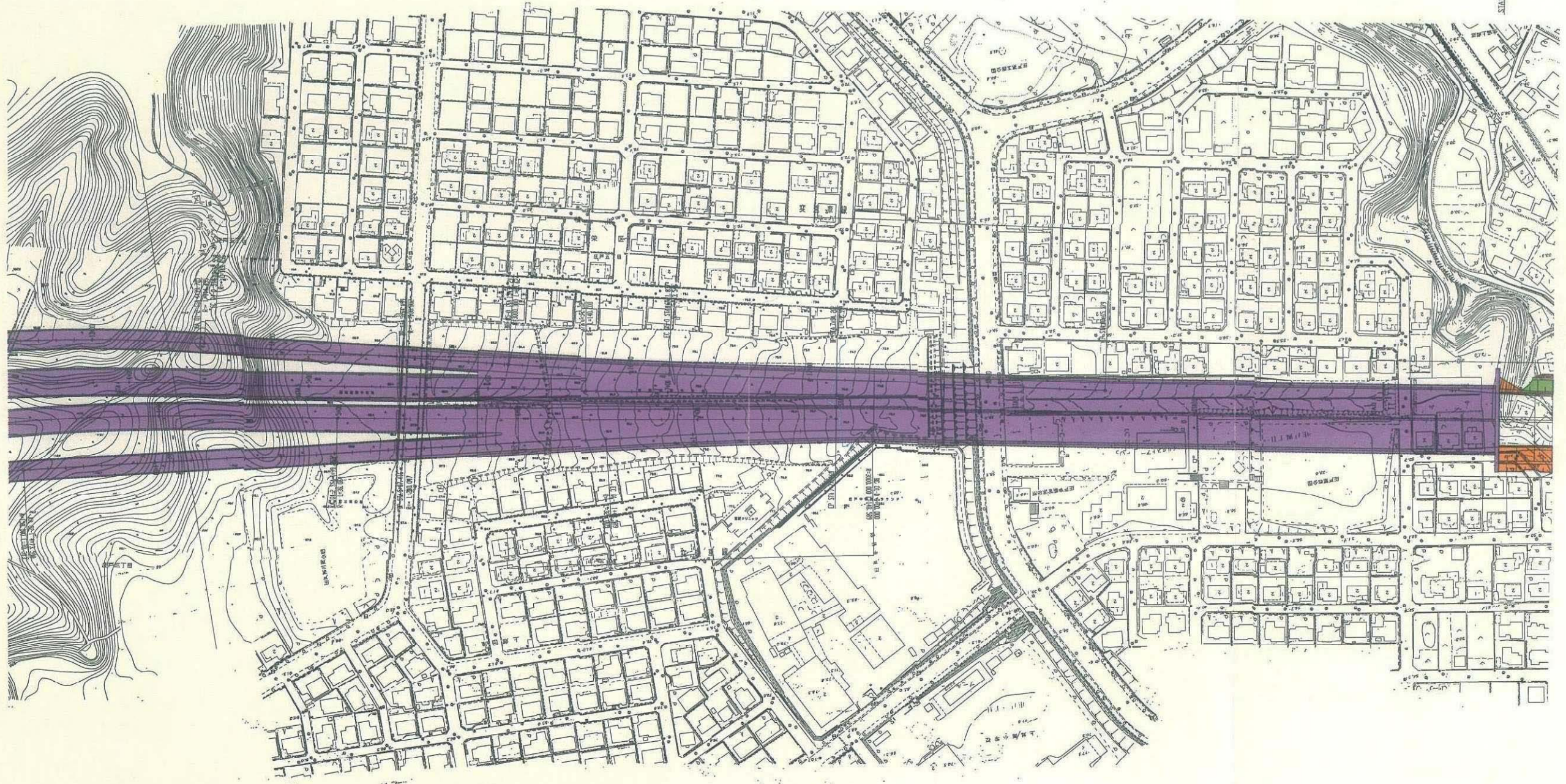

ランプ第一トンネル

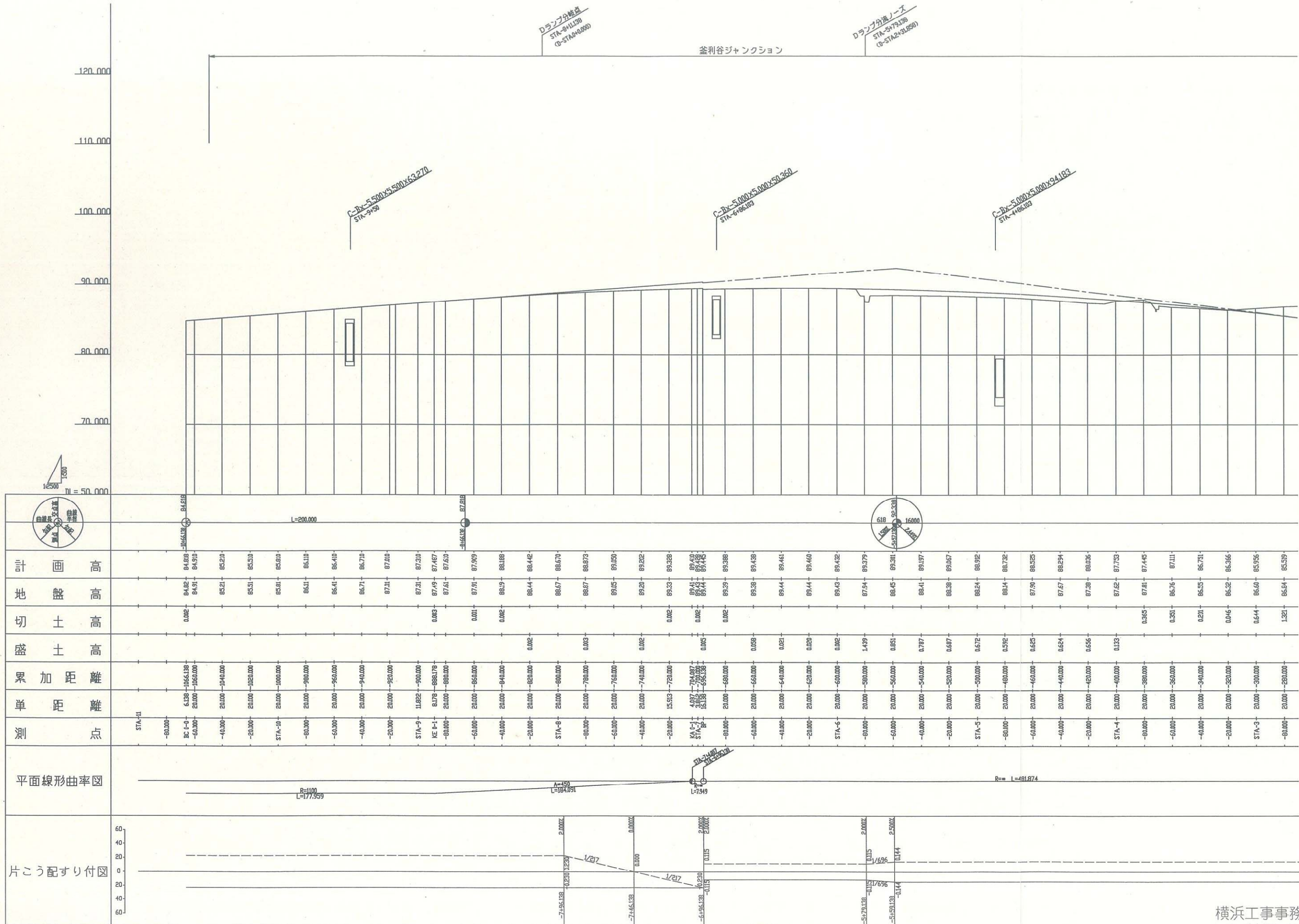

| 測点 | 単距離 | 累加距離 | 盛土高 | 切土高 | 地盤高 | 計画高 |
|---------|--------|-----------|-------|-------|-------|--------|
| STA-11 | | | | | | |
| -80.000 | | | | | 84.82 | 84.818 |
| BC 0-0 | 6.138 | -1066.138 | | 0.002 | 84.91 | 84.910 |
| -60.000 | 20.000 | -1060.000 | | | 85.21 | 85.210 |
| -40.000 | 20.000 | -1040.000 | | | 85.51 | 85.510 |
| -20.000 | 20.000 | -1020.000 | | | 85.81 | 85.810 |
| STA-10 | 20.000 | -1000.000 | | | 86.11 | 86.110 |
| -80.000 | 20.000 | -980.000 | | | 86.41 | 86.410 |
| -60.000 | 20.000 | -960.000 | | | 86.71 | 86.710 |
| -40.000 | 20.000 | -940.000 | | | 87.01 | 87.010 |
| -20.000 | 20.000 | -920.000 | | | 87.31 | 87.310 |
| STA-9 | 11.822 | -900.000 | | | 87.49 | 87.487 |
| KE 0-1 | 8.178 | -888.178 | | 0.003 | 87.61 | 87.610 |
| -80.000 | 20.000 | -860.000 | | | 87.91 | 87.910 |
| -60.000 | 20.000 | -840.000 | | | 88.19 | 88.188 |
| -40.000 | 20.000 | -820.000 | 0.002 | | 88.44 | 88.442 |
| -20.000 | 20.000 | -800.000 | 0.003 | | 88.67 | 88.670 |
| STA-8 | 20.000 | -780.000 | 0.003 | | 88.87 | 88.873 |
| -80.000 | 20.000 | -760.000 | 0.002 | | 89.05 | 89.050 |
| -60.000 | 20.000 | -740.000 | 0.002 | | 89.20 | 89.202 |
| -40.000 | 15.513 | -720.000 | 0.002 | | 89.23 | 89.228 |
| -20.000 | 4.027 | -704.027 | 0.002 | | 89.41 | 89.410 |
| KA 0-1 | 3.866 | -700.000 | 0.002 | | 89.43 | 89.438 |
| STA-7 | 16.138 | -686.138 | 0.002 | | 89.44 | 89.445 |
| -80.000 | 20.000 | -660.000 | 0.002 | | 89.39 | 89.388 |
| -60.000 | 20.000 | -640.000 | 0.002 | | 89.38 | 89.383 |
| -40.000 | 20.000 | -620.000 | 0.002 | | 89.44 | 89.441 |
| -20.000 | 20.000 | -600.000 | 0.002 | | 89.44 | 89.440 |
| STA-6 | 20.000 | -580.000 | 1.439 | | 89.43 | 89.432 |
| -80.000 | 20.000 | -560.000 | 0.851 | | 89.74 | 89.739 |
| -60.000 | 20.000 | -540.000 | 0.797 | | 88.45 | 88.450 |
| -40.000 | 20.000 | -520.000 | 0.687 | | 88.41 | 88.410 |
| -20.000 | 20.000 | -500.000 | 0.672 | | 88.38 | 88.387 |
| STA-5 | 20.000 | -480.000 | 0.596 | | 88.24 | 88.242 |
| -80.000 | 20.000 | -460.000 | 0.625 | | 88.14 | 88.142 |
| -60.000 | 20.000 | -440.000 | 0.624 | | 87.90 | 87.905 |
| -40.000 | 20.000 | -420.000 | 0.656 | | 87.67 | 87.674 |
| -20.000 | 20.000 | -400.000 | 0.133 | | 87.28 | 87.283 |
| STA-4 | 20.000 | -380.000 | 0.345 | | 87.62 | 87.623 |
| -80.000 | 20.000 | -360.000 | 0.351 | | 87.81 | 87.815 |
| -60.000 | 20.000 | -340.000 | 0.211 | | 86.76 | 86.761 |
| -40.000 | 20.000 | -320.000 | 0.016 | | 86.55 | 86.551 |
| -20.000 | 20.000 | -300.000 | 0.644 | | 86.32 | 86.366 |
| STA-3 | 20.000 | -280.000 | 1.321 | | 86.50 | 85.956 |
| -80.000 | 20.000 | -260.000 | | | 86.84 | 85.519 |

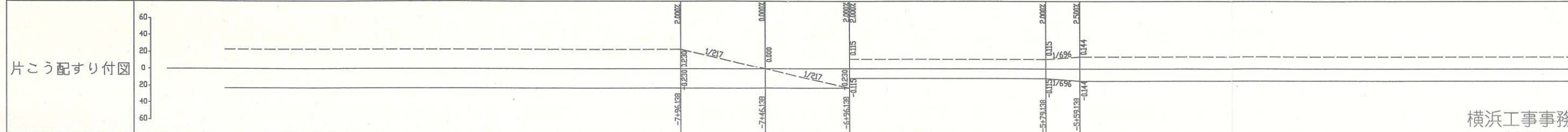
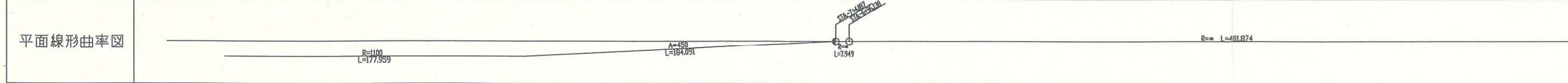

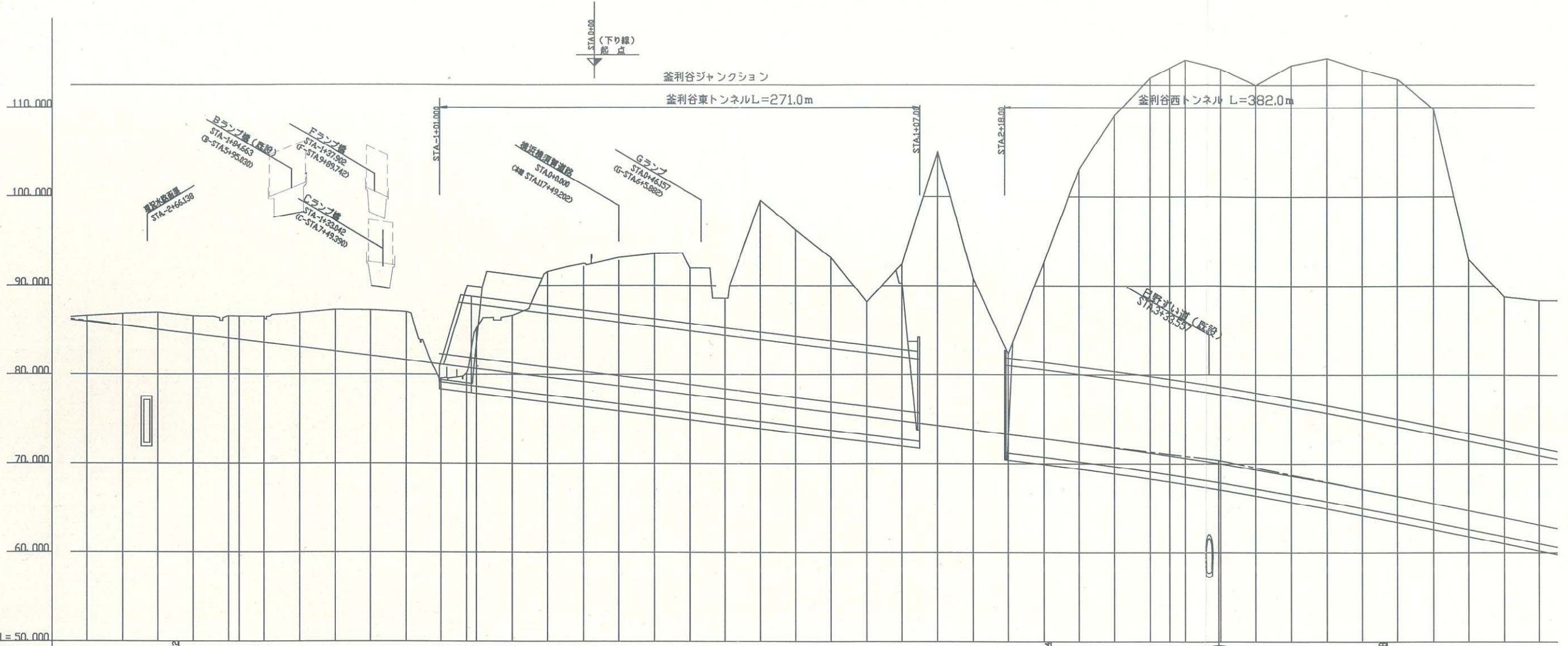

| 計 | 画 | 高 | 地 | 盤 | 高 | 切 | 土 | 高 | 盛 | 土 | 高 | 累 | 加 | 距 | 離 | 単 | 距 | 離 | 測 | 点 |
|---|---|--------|--------|--------|---|---|---|---|---|---|---|---|---|---|---|---|---|---|---|---|
| | | 85.956 | 86.60 | 0.644 | | | | | | | | | | | | | | | | |
| | | 85.519 | 86.84 | 1.321 | | | | | | | | | | | | | | | | |
| | | 85.059 | 86.98 | 1.922 | | | | | | | | | | | | | | | | |
| | | 84.572 | 86.59 | 2.018 | | | | | | | | | | | | | | | | |
| | | 84.882 | 86.58 | 2.497 | | | | | | | | | | | | | | | | |
| | | 83.942 | 86.56 | 2.618 | | | | | | | | | | | | | | | | |
| | | 83.593 | 86.54 | 2.947 | | | | | | | | | | | | | | | | |
| | | 83.103 | 86.54 | 3.037 | | | | | | | | | | | | | | | | |
| | | 82.613 | 87.30 | 4.687 | | | | | | | | | | | | | | | | |
| | | 82.124 | 87.25 | 5.126 | | | | | | | | | | | | | | | | |
| | | 81.634 | 87.84 | 5.406 | | | | | | | | | | | | | | | | |
| | | 81.144 | 79.57 | 1.574 | | | | | | | | | | | | | | | | |
| | | 80.794 | 80.794 | 0.634 | | | | | | | | | | | | | | | | |
| | | 80.653 | 85.28 | 4.625 | | | | | | | | | | | | | | | | |
| | | 80.165 | 86.67 | 6.595 | | | | | | | | | | | | | | | | |
| | | 79.675 | 91.58 | 11.985 | | | | | | | | | | | | | | | | |
| | | 79.185 | 92.13 | 12.945 | | | | | | | | | | | | | | | | |
| | | 78.695 | 92.80 | 14.104 | | | | | | | | | | | | | | | | |
| | | 78.205 | 93.60 | 15.394 | | | | | | | | | | | | | | | | |
| | | 77.715 | 93.70 | 15.984 | | | | | | | | | | | | | | | | |
| | | 77.225 | 88.60 | 11.374 | | | | | | | | | | | | | | | | |
| | | 76.735 | 99.60 | 22.863 | | | | | | | | | | | | | | | | |
| | | 76.245 | 96.30 | 20.053 | | | | | | | | | | | | | | | | |
| | | 75.755 | 93.20 | 17.443 | | | | | | | | | | | | | | | | |
| | | 75.265 | 88.20 | 12.933 | | | | | | | | | | | | | | | | |
| | | 74.775 | 92.50 | 17.722 | | | | | | | | | | | | | | | | |
| | | 74.285 | 100.50 | 26.222 | | | | | | | | | | | | | | | | |
| | | 73.795 | 90.50 | 17.102 | | | | | | | | | | | | | | | | |
| | | 73.305 | 82.40 | 9.091 | | | | | | | | | | | | | | | | |
| | | 72.815 | 92.75 | 19.931 | | | | | | | | | | | | | | | | |
| | | 72.325 | 103.10 | 30.782 | | | | | | | | | | | | | | | | |
| | | 71.835 | 109.10 | 37.314 | | | | | | | | | | | | | | | | |
| | | 71.345 | 113.20 | 42.079 | | | | | | | | | | | | | | | | |
| | | 70.855 | 114.41 | 43.561 | | | | | | | | | | | | | | | | |
| | | 70.365 | 115.30 | 44.677 | | | | | | | | | | | | | | | | |
| | | 69.875 | 114.20 | 44.307 | | | | | | | | | | | | | | | | |
| | | 69.385 | 112.50 | 43.170 | | | | | | | | | | | | | | | | |
| | | 68.895 | 114.70 | 46.866 | | | | | | | | | | | | | | | | |
| | | 68.405 | 115.50 | 47.594 | | | | | | | | | | | | | | | | |
| | | 67.915 | 114.20 | 47.055 | | | | | | | | | | | | | | | | |
| | | 67.425 | 113.10 | 45.782 | | | | | | | | | | | | | | | | |
| | | 66.935 | 113.10 | 45.778 | | | | | | | | | | | | | | | | |
| | | 66.445 | 109.60 | 44.248 | | | | | | | | | | | | | | | | |
| | | 65.955 | 93.00 | 28.248 | | | | | | | | | | | | | | | | |
| | | 65.465 | 88.60 | 24.828 | | | | | | | | | | | | | | | | |
| | | 64.975 | 88.40 | 25.248 | | | | | | | | | | | | | | | | |

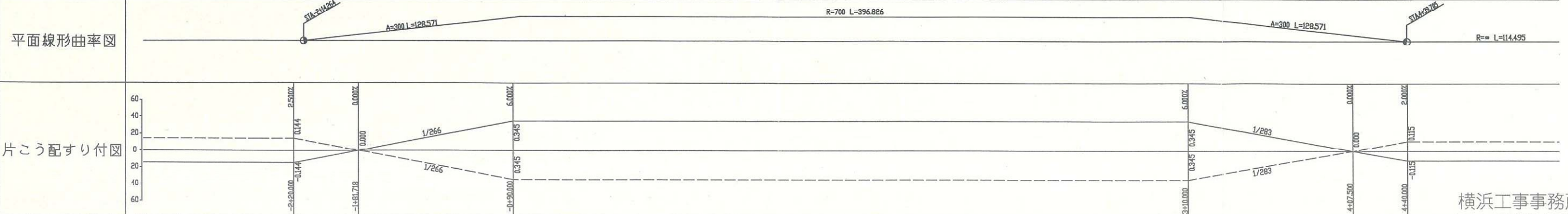

クラップ合流ノズ
 STA.6+54.202
 (C-STA.15+75.486)

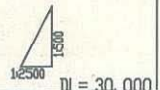
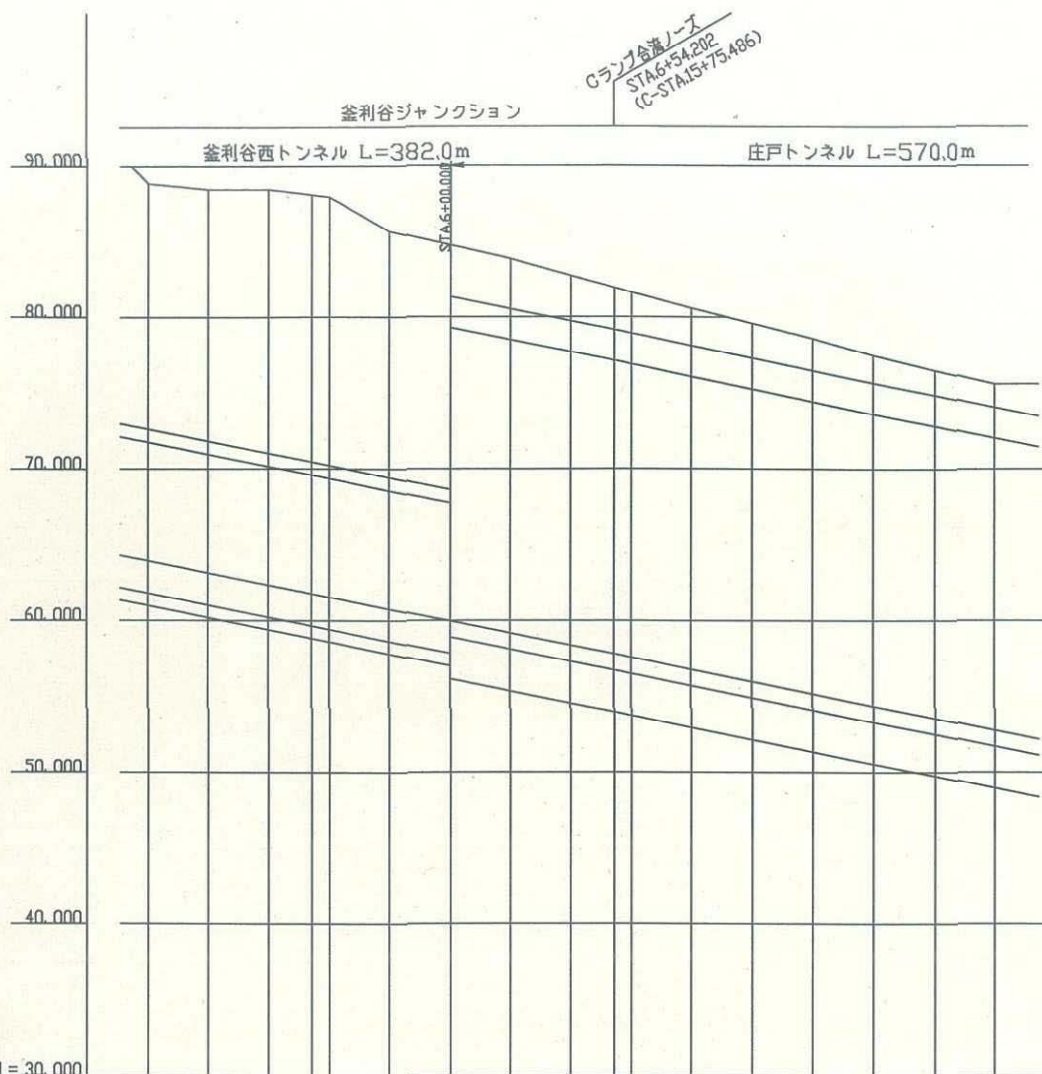

| | | | | | | | | | | | | | | | | | | |
|----------|------------------|---------|---------------|---------|------------------|---------|---------------------|---------|------------------|---------|---------|---------|---------|---------|---------|---------|---------|---------|
| 計画高さ | 63.952 | 63.182 | 62.352 | 61.794 | 61.532 | 60.752 | 99.952 | 99.182 | 98.552 | 97.784 | 97.532 | 96.752 | 95.982 | 95.182 | 94.382 | 93.552 | 92.752 | 92.184 |
| 地盤高さ | 88.80 | 88.40 | 88.40 | 88.05 | 87.90 | 85.60 | 84.70 | 83.80 | 82.70 | 81.82 | 81.60 | 80.50 | 79.60 | 78.60 | 77.50 | 76.50 | 76.50 | 74.80 |
| 切土高さ | 24.828 | 25.216 | 26.048 | 26.261 | 26.348 | 24.948 | 24.748 | 24.648 | 24.948 | 24.136 | 24.048 | 23.948 | 23.648 | 23.448 | 23.148 | 22.948 | 23.748 | 22.616 |
| 盛土高さ | | | | | | | | | | | | | | | | | | |
| 累加距離 | 500.000 | 520.000 | 540.000 | 554.199 | 560.000 | 580.000 | 600.000 | 620.000 | 640.000 | 654.202 | 660.000 | 680.000 | 700.000 | 720.000 | 740.000 | 760.000 | 780.000 | 794.202 |
| 単距離 | 20.000 | 20.000 | 20.000 | 14.199 | 5.801 | 20.000 | 20.000 | 20.000 | 20.000 | 14.202 | 5.798 | 20.000 | 20.000 | 20.000 | 20.000 | 20.000 | 20.000 | 14.202 |
| 測点 | STA.5 +20.000 | +40.000 | EP +60.000 | +80.000 | STA.6 +20.000 | +40.000 | 6+54.202 +60.000 | +80.000 | STA.7 +20.000 | +40.000 | +60.000 | +80.000 | +94.202 | | | | | |
| 平面線形曲率図 | | | | | | | | | | | | | | | | | | |
| 片こう配すり付図 | | | | | | | | | | | | | | | | | | |

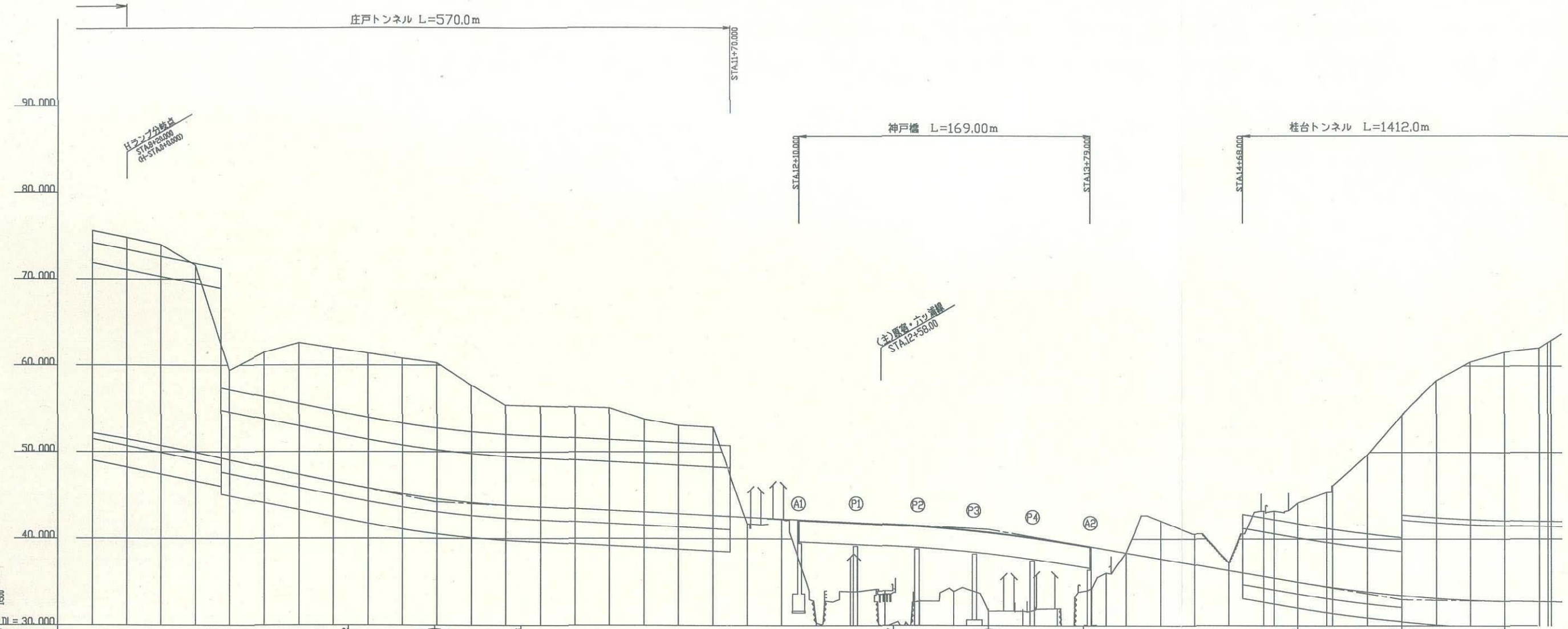

| 測点 | 単距離 | 累加距離 | 盛土高 | 切土高 | 地盤高 | 計画高 |
|------------|--------|---------|-------|--------|--------|--------|
| STA.8 | 00.000 | 000.000 | | 22.512 | 74.74 | 52.198 |
| 20.000 | 20.000 | 020.000 | | 23.402 | 74.80 | 51.398 |
| 40.000 | 20.000 | 040.000 | | 23.402 | 74.00 | 50.598 |
| 60.000 | 20.000 | 060.000 | | 21.802 | 71.60 | 49.798 |
| 80.000 | 20.000 | 080.000 | | 10.402 | 59.40 | 48.998 |
| STA.9 | 20.000 | 090.000 | | 13.302 | 61.50 | 48.198 |
| 20.000 | 20.000 | 092.000 | | 15.202 | 62.60 | 47.398 |
| 40.000 | 20.000 | 094.000 | | 15.402 | 62.00 | 46.598 |
| 60.000 | 20.000 | 096.000 | | 15.582 | 61.40 | 45.808 |
| 80.000 | 20.000 | 098.000 | | 15.653 | 60.80 | 45.147 |
| STA.10 | 20.000 | 100.000 | | 15.703 | 60.30 | 44.597 |
| 20.000 | 20.000 | 102.000 | | 13.533 | 57.70 | 44.167 |
| 40.000 | 20.000 | 104.000 | | 11.541 | 55.40 | 43.859 |
| 60.000 | 20.000 | 106.000 | | 11.648 | 55.30 | 43.652 |
| 80.000 | 20.000 | 108.000 | | 11.744 | 55.20 | 43.456 |
| STA.11 | 20.000 | 110.000 | | 11.839 | 55.10 | 43.261 |
| 20.000 | 20.000 | 112.000 | | 10.735 | 53.80 | 43.065 |
| 40.000 | 20.000 | 114.000 | | 10.230 | 53.10 | 42.870 |
| 60.000 | 20.000 | 116.000 | | 10.226 | 52.90 | 42.674 |
| 80.000 | 20.000 | 118.000 | 0.78 | | 41.70 | 42.478 |
| STA.12 | 20.000 | 120.000 | 0.06 | | 42.22 | 42.282 |
| +10.000 | 10.000 | 120.000 | | | 42.185 | |
| +20.000 | 10.000 | 120.000 | 11.79 | | 30.30 | 42.087 |
| KAI-1 | 3.000 | 123.000 | | | 30.11 | 42.087 |
| +40.000 | 16.553 | 124.000 | 7.99 | | 33.90 | 41.891 |
| +43.000 | 3.000 | 124.000 | | | 41.862 | |
| +60.000 | 17.000 | 126.000 | 7.72 | | 33.98 | 41.696 |
| +78.500 | 18.500 | 127.500 | | | | |
| +80.000 | 15.500 | 128.000 | 8.68 | | 32.79 | 41.491 |
| 13 + 0.000 | 20.000 | 130.000 | 7.26 | | 33.91 | 41.167 |
| +12.000 | 12.000 | 132.000 | | | 40.942 | |
| +20.000 | 8.000 | 132.000 | 9.12 | | 31.66 | 40.779 |
| +40.000 | 20.000 | 134.000 | 8.64 | | 31.66 | 40.300 |
| +45.500 | 5.500 | 134.500 | | | 40.153 | |
| KEL-1 | 6.071 | 135.571 | | | 31.91 | 39.993 |
| +60.000 | 8.019 | 136.000 | 7.78 | | 31.95 | 39.793 |
| +78.000 | 19.000 | 138.000 | 4.78 | | 39.11 | 39.082 |
| +80.000 | 12.000 | 138.000 | | | 34.30 | 39.082 |
| +88.300 | 8.300 | 138.300 | | | 36.11 | 38.802 |
| STA.14 | 11.700 | 140.000 | | 0.09 | 38.59 | 38.406 |
| +20.000 | 20.000 | 142.000 | | 4.37 | 42.18 | 37.731 |
| +40.000 | 20.000 | 144.000 | | 3.51 | 46.59 | 37.055 |
| +60.000 | 20.000 | 146.000 | 3.18 | | 37.27 | 36.379 |
| +80.000 | 20.000 | 148.000 | | 7.53 | 43.23 | 35.703 |
| +85.100 | 6.000 | 148.100 | | | 43.24 | 35.497 |
| STA.15 | 13.900 | 150.000 | | 9.17 | 44.20 | 35.027 |
| +15.500 | 16.500 | 156.500 | | 11.78 | 45.41 | 34.703 |
| KEL-2 | 3.900 | 156.500 | | | 45.41 | |
| +40.000 | 20.000 | 154.000 | | 15.85 | 49.73 | 33.881 |
| +60.000 | 20.000 | 156.000 | | 20.85 | 54.32 | 33.461 |
| +80.000 | 20.000 | 158.000 | | 25.15 | 58.29 | 33.143 |
| STA.16 | 20.000 | 160.000 | | 27.53 | 64.46 | 32.928 |
| +20.000 | 20.000 | 162.000 | | 28.83 | 61.64 | 32.815 |

平面線形曲率図

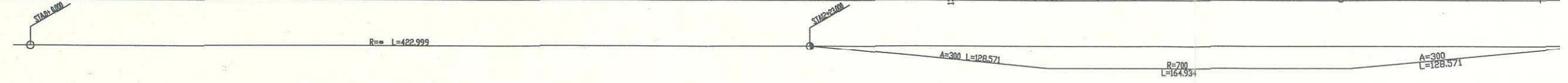

片こう配すり付図

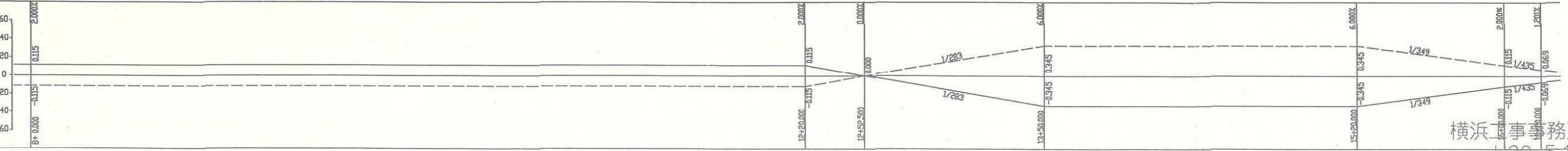

標準横断図

トンネル部

STA 2+60

(下り線)

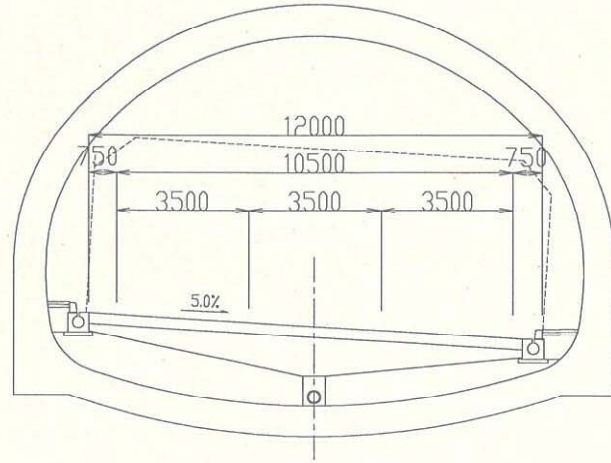

(上り線)

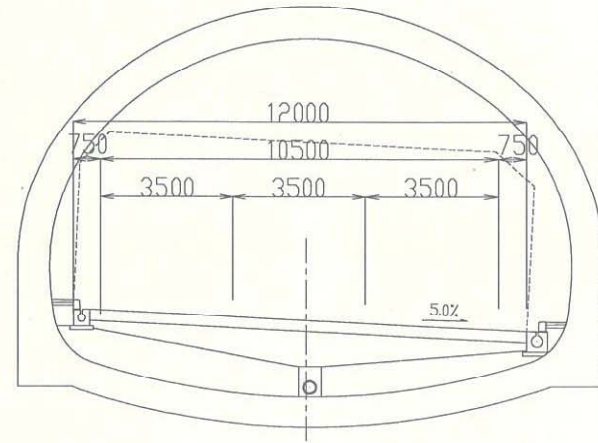

STA 40+00

(下り線)

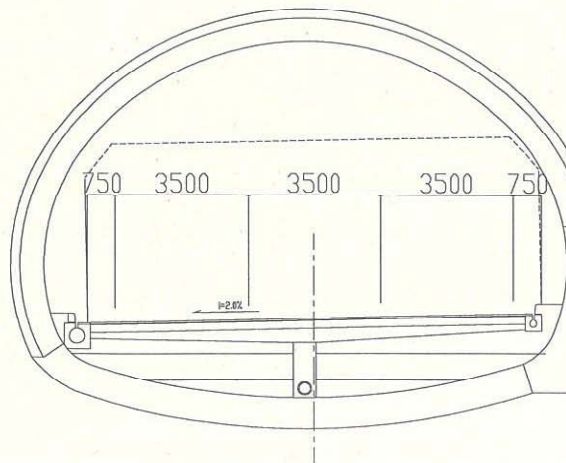

(上り線)

